

iMiNi Fan 20*20*5 MM Series

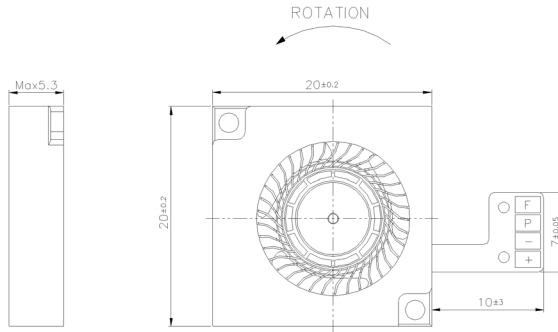

Housing : Plastic (UL 94V-0)
 Impeller : Plastic (UL 94V-0)
 Bearing : Hydraulic Bearing
 Operating temp : -10 ~ 60°C
 Mass : 1.35g

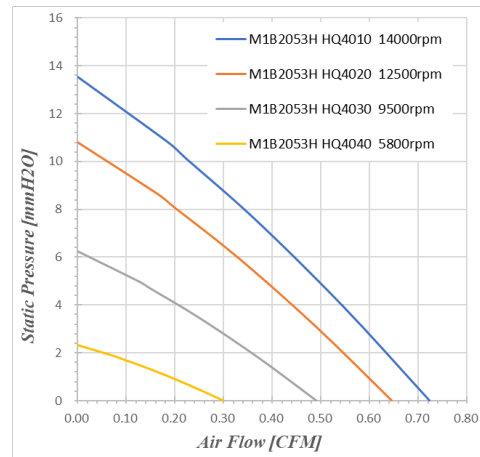

20% Duty Speed Sound Quality Spectrum

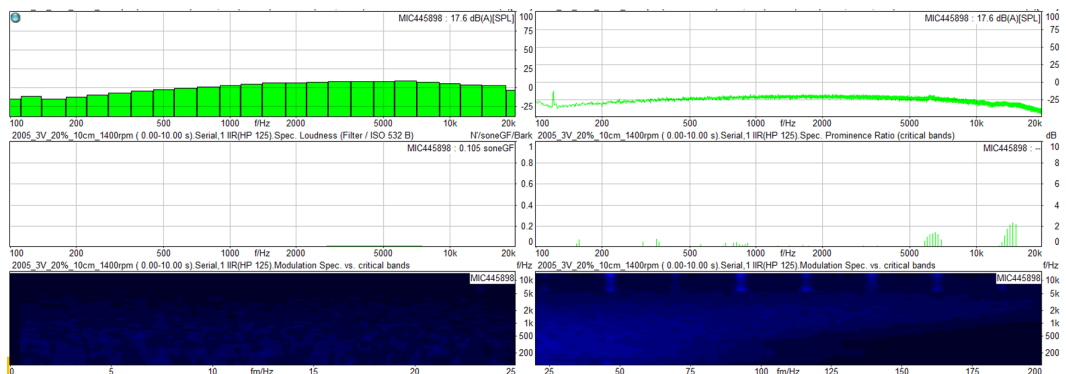

產品別	Model No.	Control Type	Bearing Type	Rated Voltage	Operating Voltage Range	Operating Temp.	Speed	Input Current	Input Power	Maximum Air Flow		Maximum Air Pressure		Noise	
				VDC	VDC	°C				R.P.M	Amp	Watt	CFM		l/min
Blower 2005 3V Series	M1B2053H	HQ4010	+/-FG/PWM	Hydraulic	3	2.5~3.5	-10~60	14000	0.25	0.75	0.72	20.47	132.7	13.53	35.6
	M1B2053H	HQ4020	+/-FG/PWM	Hydraulic	3	2.5~3.5	-10~60	12500	0.16	0.48	0.65	18.27	105.8	10.79	33.2
	M1B2053H	HQ4030	+/-FG/PWM	Hydraulic	3	2.5~3.5	-10~60	9500	0.096	0.288	0.49	13.89	61.1	6.23	27.6
	M1B2053H	HQ4040	+/-FG/PWM	Hydraulic	3	2.5~3.5	-10~60	5800	0.045	0.135	0.30	8.48	22.8	2.32	17.4